



GAMME

Gold

PERSONNALISEZ VOTRE CANAPÉ
AU FIL DE VOS ENVIES

- JANVIER 2025 -

HOME SPIRIT

FRANCE



HOME SPIRIT

FRANCE

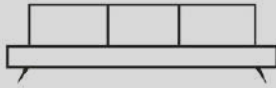

Fabricant Français de canapé dans les Hauts de France depuis 1965

#MEUBLEZ VOUS FRANÇAIS

17 rue des forts
59960 Neuville-en-Ferrain
France

contact@homespirit.fr
03 28 33 07 28
www.homespirit.fr

FABRICANT FRANÇAIS ENGAGÉ !

Située au coeur de la région Lilloise, Home Spirit est une entreprise familiale **créée en 1965**. Fidèle à notre démarche "Fabrication française", **80% de nos fournitures sont achetées à moins de 100km**.

OSEZ L'ÉCO-QUALITÉ !

Home Spirit s'engage pour une conception et une réalisation éco-responsable.



bois issus de forêts gérées
durablement



matériaux de fabrication
recyclés et recyclables

CRÉÉ POUR ET AVEC VOUS !

Notre Atelier de Design vous propose des **produits uniques** grâce aux multiples possibilités de **personnalisation**.



HOME SPIRIT

FRANCE

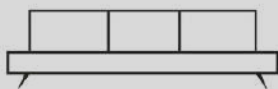

French sofa manufacturer from 1965

#MEUBLEZ VOUS FRANÇAIS

17 rue des forts
59960 Neuville-en-Ferrain
France

contact@homespirit.fr
+33 (0) 3 28 33 98 26
www.homespirit.fr

FRENCH MANUFACTURER COMMITTED !

Located in the heart of Europe, Home Spirit is a family-run business **created in 1965**. Faithful to our "French Manufacturing" approach, **80% of our supplies are purchased less than 100km away**.

DARE THE ECO-QUALITY !

Home Spirit is committed to eco-responsible design and production.



Wood from sustainable forests



Recycled and recyclable manufacturing materials

CREATE FOR AND WITH YOU !

Our Design Workshop offers you **unique products** thanks to the multiple possibilities of **customization**.



FORMULE FLASH

4 modèles / models
8 tailles / sizes
2 tissus / fabrics

Fabrication sous 1 semaine
Manufactured in 1 week

BIARRITZ



3 pl / seats

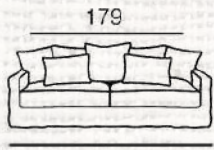

179

206

4 pl / seats

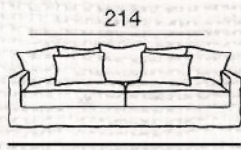

214

240

BISCARROSSE



3 pl / seats

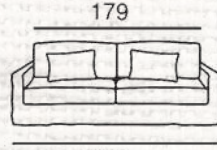

179

206

4 pl / seats

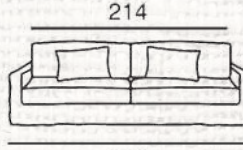

214

240

CAP FERRET



4 pl / seats

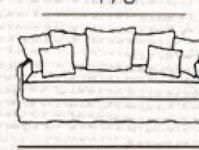

173

185

5 pl / seats

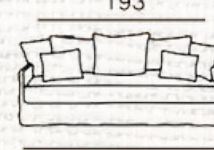

193

205

BIDART



3 pl / seats

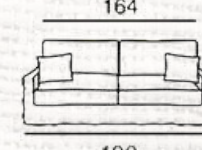

164

190

Mat. 140 cm

4 pl / seats

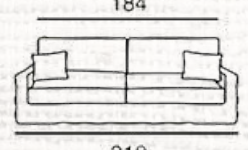

184

210

Mat. 160 cm

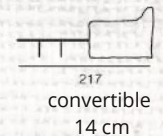

217
convertible
14 cm

CHOIX DU TISSU
FABRIC SELECTION

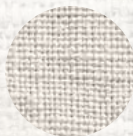

SWEET
ECRU

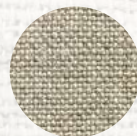

NEWLIN
NATUREL

HOME SPIRIT

FRANCE

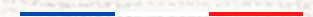
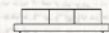

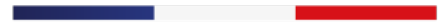

MADE IN FRANCE

1965

Accueillant & Rétro



HOME SPIRIT

FRANCE

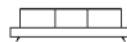

1965

Accueillant & Rétro

MADE IN FRANCE

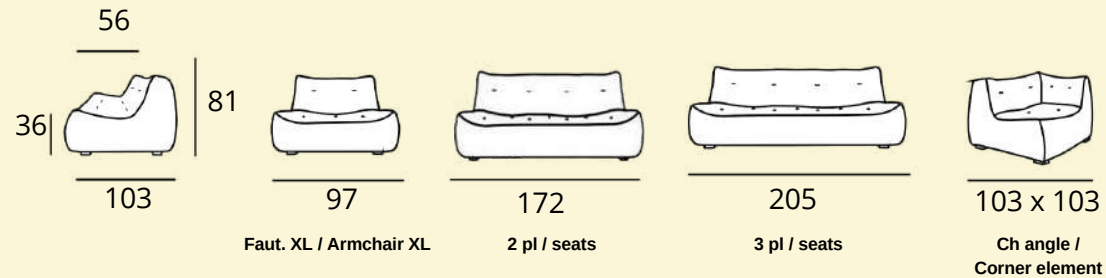

Structure : Mousse HR 35 kg/m³, mousse polyéther 17 kg/m³ + HR 26 kg/m³, posé sur un panneau de bois. **Pieds :** Bois. **Finition :** Tapissier.

Frame: HR foam 35 kg/m³, HR foam 35 kg/m³ + polyether foam 17 kg/m³ + HR 26 kg/m³, on a wooden panel. **Legs:** Wood. **Finish:** Fixed cover.

HOME SPIRIT

FRANCE



homespirit.fr

MADE IN FRANCE

ALBI

Aisance & Volume



HOME SPIRIT

FRANCE

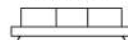

ALBI

Aisance & Volume

MADE IN FRANCE

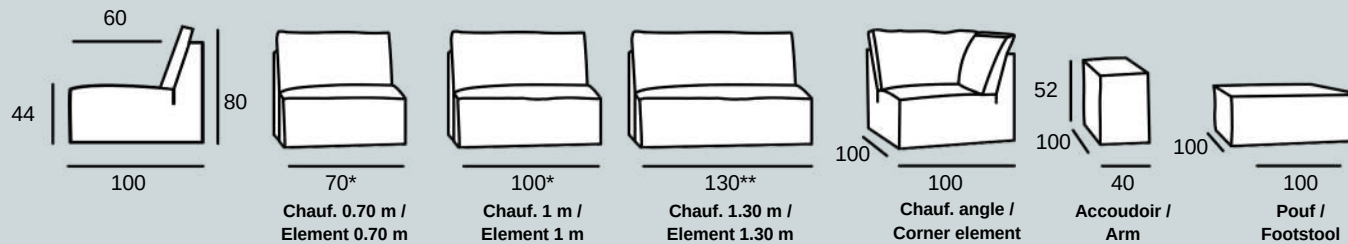

Option : largeur sur mesure : * de 70 à 100 cm. ** de 100 à 130 cm.

Option: custom made elements: * from 70 to 100 cm. ** from 100 to 130 cm.

Structure : Hêtre, panneaux multiplex et panneaux de fibres. Structure enrobée de mousse polyuréthane. Manchette enrobée de ouate 650 g. Suspension ressorts Nosags. **Assise :** HR 35 kg/m³ + HR 25 kg/m³ + ouate. **Dossier :** remplissage plumes/flocons. **Couture :** Bord à bord, pincé. **Pieds :** Plastique. **Finition :** tapissier, non convertible.

Frame: Solid beech wood, multiplex panels and fiber panels . Frame wrapped in foam cover and double layered with a fiber cover. Suspension Nosags springs. **Seat cushions:** HR foam 35 kg/m³ + HR foam 25 kg/m³ + cotton-wool. **Back cushions:** Feathers/foam flakes. **Sewing:** Pinched sewing. **Legs:** Plastic. **Finish:** Fixed covers.

HOME SPIRIT

FRANCE



homespirit.fr

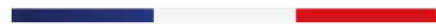

MADE IN FRANCE

ARLES

Aisance & Volume



HOME SPIRIT

FRANCE

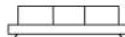

ARLES

Aisance & Volume

MADE IN FRANCE

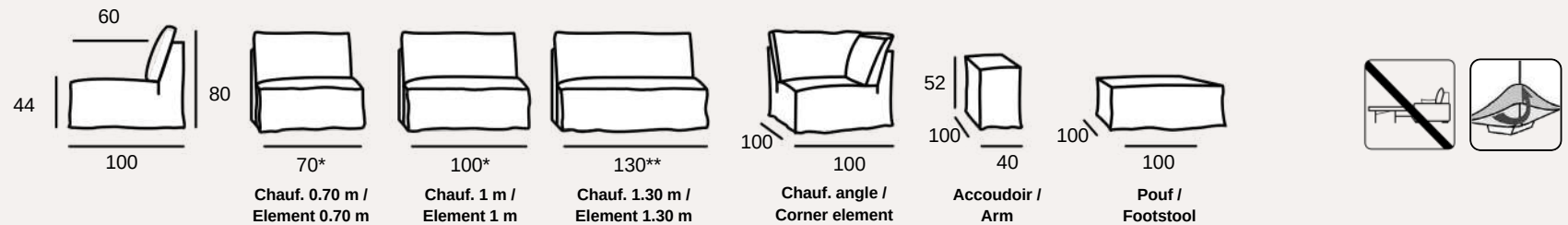

Option : largeur sur mesure : * de 70 à 100 cm. ** de 100 à 130 cm.

Option: custom made elements: * from 70 to 100 cm. ** from 100 to 130 cm.

Structure : Hêtre, panneaux multiplex et panneaux de fibres. Structure enrobée de mousse polyuréthane. Manchette enrobée de ouate 650 g. Suspension ressorts Nosags. **Assise :** HR 35 kg/m³ + HR 25 kg/m³ + ouate. **Dossier :** remplissage plumes/flocons. **Couture :** Surpiqûre plate. **Pieds :** Plastique. **Finition :** 100% déhoussable, non convertible.

Frame: Solid beech wood, multiplex panels and fiber panels . Frame wrapped in foam cover and double layered with a fiber cover. Suspension Nosags springs. **Seat cushions:** HR foam 35 kg/m³ + HR foam 25 kg/m³ + cotton-wool. **Back cushions:** Feathers/foam flakes. **Sewing:** Flat topstitching. **Legs:** Plastic. **Finish:** Removable covers.

HOME SPIRIT

FRANCE



homespirit.fr

MADE IN FRANCE

AUSTIN

Caractère & Éléance



HOME SPIRIT

FRANCE

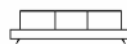

AUSTIN

Caractère & Éléance

MADE IN FRANCE

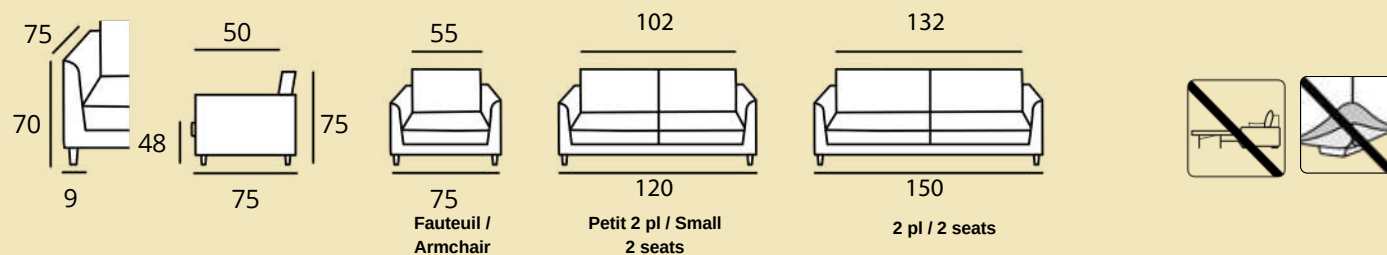

Structure : Hêtre, panneaux multiplex et panneaux de fibres. Structure enrobée de mousse polyuréthane et d'une sous-housse en foamé agrafée, suspension sangles. **Assise** : Mousse HR 35 kg/m³ + HR 23 kg/m³. **Dossier** : Remplissage fibres creuses siliconées. **Pieds** : Bois wengé. **Finition** : Tapissier.

Frame: Beech wood, multiplex and fiber panels. Frame wrapped in foam cover. Suspension elastic bands. **Seat cushions**: HR foam 35 kg/m³ + HR foam 23 kg/m³. **Back cushions**: fibers. **Legs** : Wooden in wenge color. **Finish**: Fixed covers.

HOME SPIRIT

FRANCE



homespirit.fr

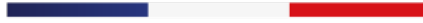

MADE IN FRANCE

BANDOL

Confort & Naturel



HOME SPIRIT

FRANCE



BANDOL

Confort & Naturel

MADE IN FRANCE

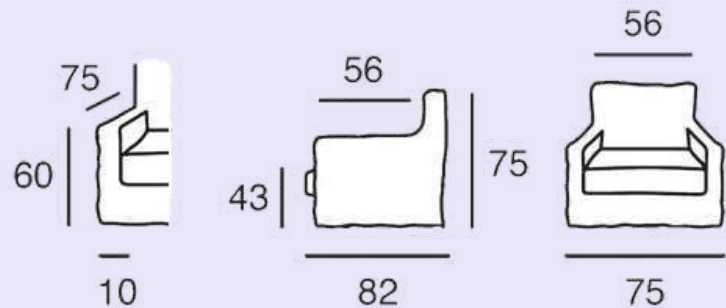

Fauteuil / Armchair



* Option : pivotant / swivel



Structure : Hêtre, panneaux multiplex et panneaux de fibres. Structure enrobée de mousse polyuréthane et d'une sous-housse en foamé agrafée, suspension ressorts Nosags. **Assise** : Plumtex HR 35 kg/m³ + percale remplissage plumes. **Pieds** : Bois. **Finition** : Déhoussable.
*Option : Fauteuil pivotant

Frame: Beech wood, multiplex and fiber panels. Frame wrapped in foam cover. Suspension Nosag springs.
Seat cushions: Plumtex HR foam 35 kg/m³ + layer of feathers. **Legs:** Wooden. **Finish:** Removable covers.
*Option : Swivel armchair



homespirit.fr

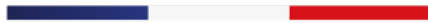

MADE IN FRANCE

BIARRITZ & BONDUES

Charme & Naturel



HOME SPIRIT

FRANCE



BIARRITZ & BONDUES

Charme & Naturel

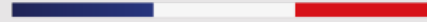

MADE IN FRANCE

BIARRITZ Profondeur 100 cm

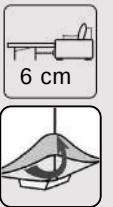
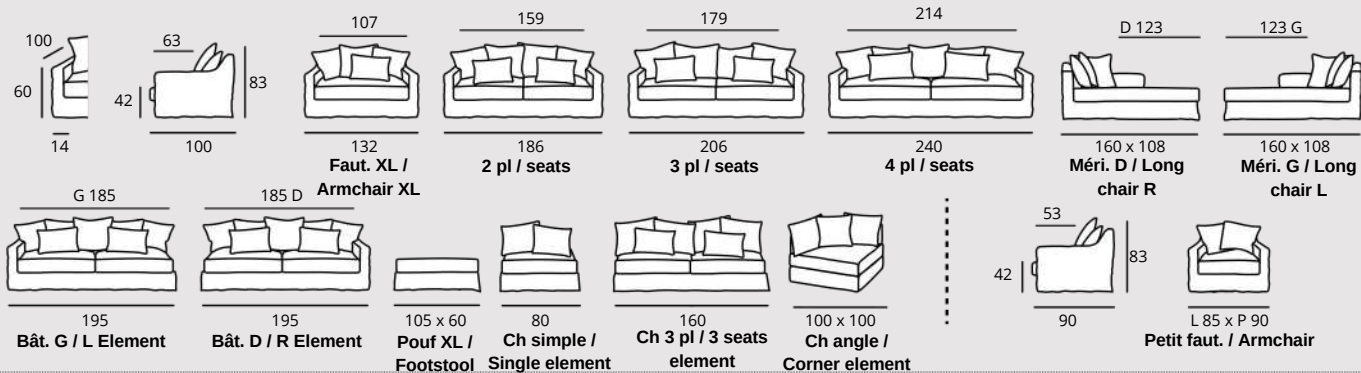

BONDUES Profondeur 90 cm

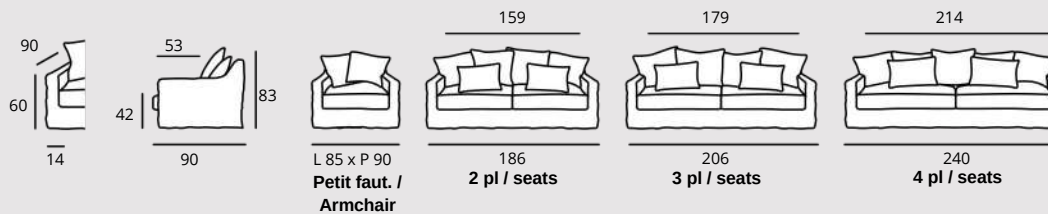

Structure : Hêtre, panneaux multiplex et panneaux de fibres. Structure enrobée de mousse polyuréthane et d'une sous-housse en foamé agrafée, suspension ressorts Nosags. **Assise** : Plumtex HR 35 kg/m³ + percale remplissage plumes. **Dossier** : Coussins 60x60 cm, remplissage plumes/flocons. **Coussins de déco** : Remplissage plumes/flocons, 60x45 cm. **Pieds** : Bois. **Finition** : Déhoussable. ***Option** : Petit fauteuil pivotant

Frame: Beech wood, multiplex and fiber panels. Frame wrapped in foam cover. Suspension no-sag springs. **Seat cushions**: Plumtex HR foam 35 kg/m³ + layer of feathers. **Back cushions**: cushions 60x60 cm, feathers/foam flakes. **Deco cushions**: cushions 60x45 cm, feathers/foam flakes. **Legs**: Wooden. **Finish**: Removable covers. ***Option** : Swivel armchair

Nb de coussins (cushions number) : Dos/Déco (back/deco) = Fauteuil : 1/1 - Faut XL : 3/1 - 2 pl : 4/2 - 3 pl : 4/2 - 4 pl : 5/2 - Méridienne : 2/1 - Bâtard : 5/2 - Ch simple : 2/0 - Ch double : 4/2 - Ch angle : 3/0.



homespirit.fr

MADE IN FRANCE

BISCARROSSE & BRUGES

Charme & Naturel



HOME SPIRIT

FRANCE



BISCARROSSE & BRUGES

Charme & Naturel

MADE IN FRANCE

BISCARROSSE

Profondeur 100 cm

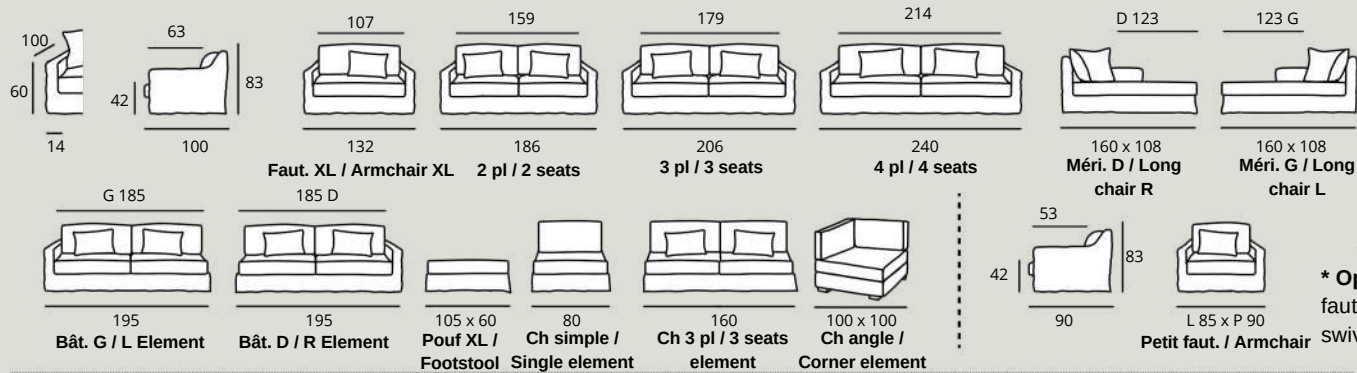

BRUGES

Profondeur 90 cm

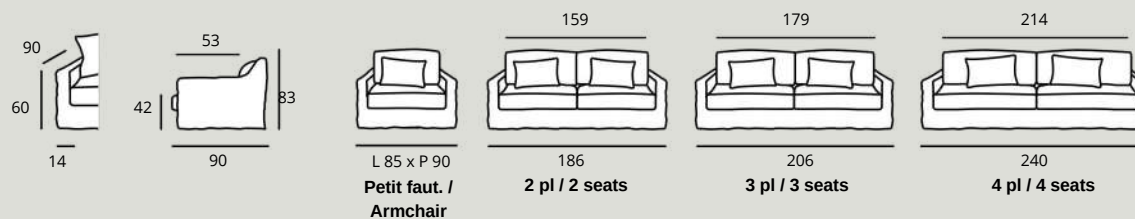

Structure : Hêtre, panneaux multiplex et panneaux de fibres. Structure enrobée de mousse polyuréthane et d'une sous-housse en foamé agrafée, suspension ressorts Nosags. **Assise** : Plumtex HR 35 kg/m³ + percale remplissage plumes. **Dossier** : Coussins rectangulaires, remplissage plumes/flocons. **Coussins de déco** : Remplissage plumes/flocons, 60x45 cm. **Pieds** : Bois. **Finition** : Déhoussable. ***Option** : Petit fauteuil pivotant

Frame: Beech wood, multiplex and fiber panels. Frame wrapped in foam cover. Suspension no-sag springs. **Seat cushions**: Plumtex HR foam 35 kg/m³ + layer of feathers. **Back cushions**: rectangular cushions, feathers/foam flakes. **Deco cushions**: cushions 60x45 cm, feathers/foam flakes. **Legs**: Wooden. **Finish**: Removable covers. ***Option** : Swivel armchair

HOME SPIRIT

FRANCE



homespirit.fr

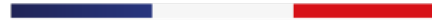

MADE IN FRANCE

BIDART

Convertible Grand Confort 14cm



HOME SPIRIT

FRANCE



BIDART

Convertible Grand Confort 14cm

MADE IN FRANCE

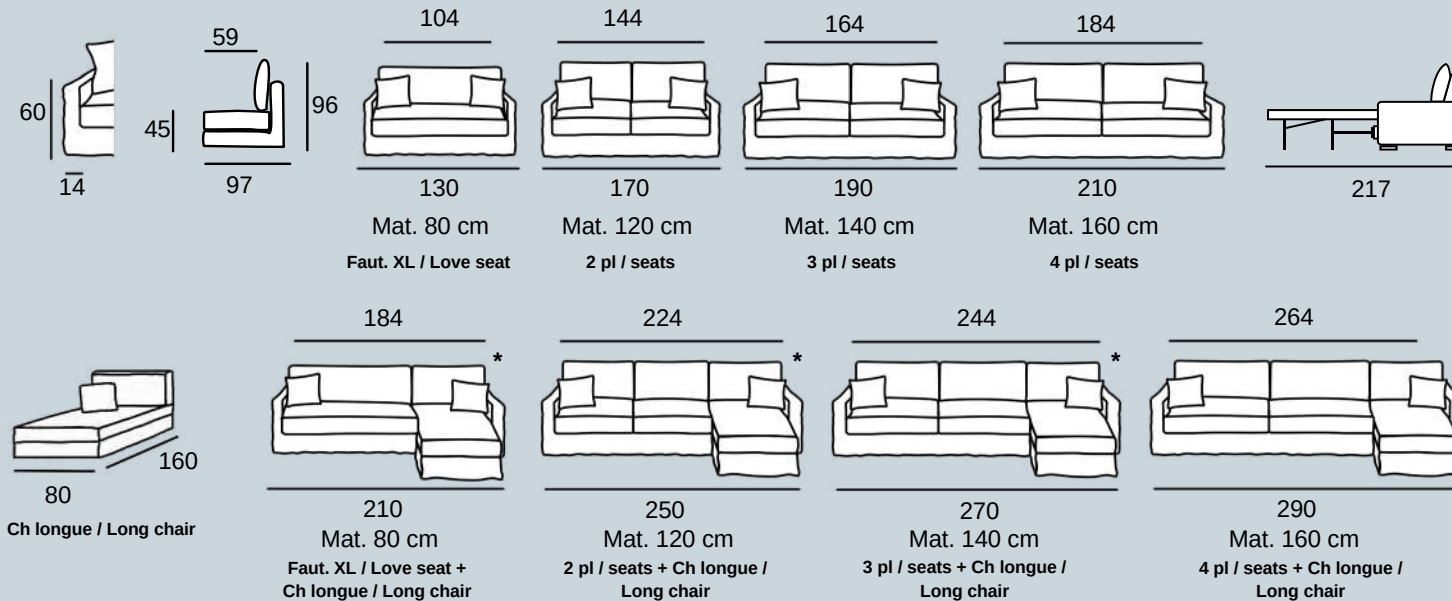

*Angle réversible à gauche ou à droite

*Corner réversible R/L

Structure : Hêtre, panneaux multiplex et panneaux de fibres. Mécanique autoporteuse sommier grille et sangles entrecroisées en pieds ou mécanique autoporteuse Black Edition sommier latte (bi-zone pour 3 et 4 places) et sangles entrecroisées en pieds. **Assise** : Plumtex HR 35 kg/m³ + percale remplissage plumes. **Dossier** : remplissage plumes/flocons. **Coussins de déco** : Coussins 60 x 45 cm, remplissage plumes/flocons. **Finition** Déhoussable. **Pieds** : Bois. **Matelas** : 14 cm Mousse HR Optimum 35 kg/ m³. Dimensions : 80-120-140-160 x 200 cm. Assises et dossiers restent en place à l'ouverture de la mécanique.

Frame: Solid beech wood, multiplex panels and fiber panels. **Selfsupporting bed mechanism** : Grid and elastic bands or selfsupporting bed mechanism Black Edition : slatted (bi-zone for 3 and 4 seats) and elastic bands. **Seat cushions**: Plumtex HR 35 kg/m³ + layer of feathers. **Back cushions**: filled with feathers/foam flakes. **Deco cushions**: cushions 60 x 45 cm, feathers/foam flakes. **Finish**: Removable covers. **Legs**: Wooden. **Mattress**: 14 cm thick, HR foam Optimum 35 kg/m³. Dimensions 80-120-140-160 x 200 cm. No need to remove back and seat cushions when folding and unfolding.

HOME SPIRIT

FRANCE



homespirit.fr

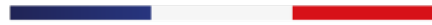

MADE IN FRANCE

BEAUSSET

Élégant & Intemporel



HOME SPIRIT

FRANCE

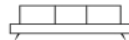

BEAUSSET

Élégant & Intemporel

MADE IN FRANCE

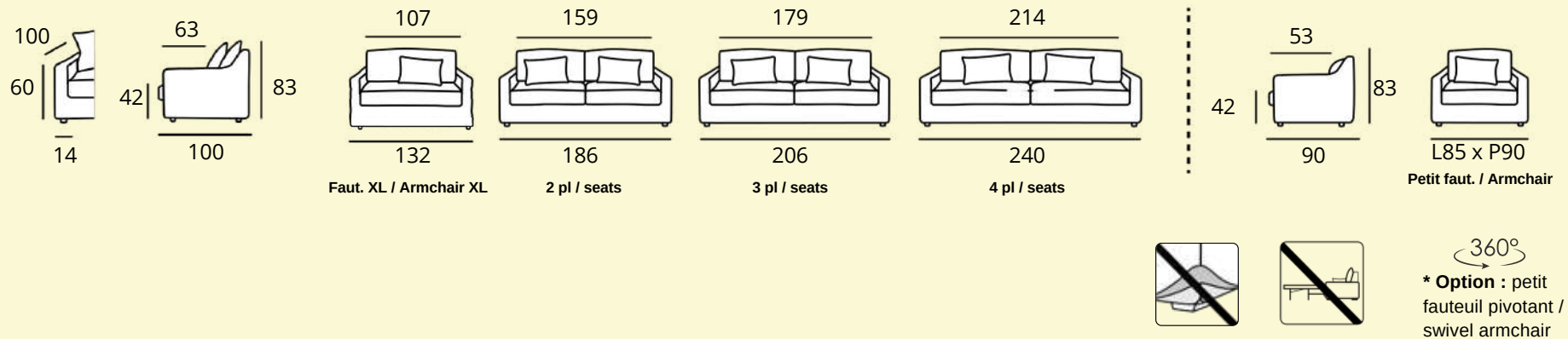

Structure : Hêtre, panneaux multiplex et panneaux de fibres. Structure enrobée de mousse polyuréthane et d'une sous-housse en foamé agrafée, suspension ressorts Nosags. **Assise** : Plumtex HR 35 kg/m³ + percale remplissage plumes. **Dossier** : coussins rectangulaires, remplissage plumes/flocons. **Coussins déco** : Coussins 60 x 45 cm, remplissage plumes/flocons. **Pieds** : Bois, teinté wengé. **Finition** : Tapissier.

Frame: Beech wood, multiplex and fiber panels. Frame wrapped in foam cover. Suspension no-sag springs. **Seat cushions**: Plumtex HR foam 35 kg/m³ + layer of feathers. **Back cushions**: rectangular cushions, feathers/foam flake. **Deco cushions**: cushions 60x45 cm, feathers/foam flake. **Legs**: Wooden, wengé. **Finish**: Fixed covers.

HOME SPIRIT

FRANCE



homespirit.fr

MADE IN FRANCE

BLAGNAC

Élégant & Intemporel



HOME SPIRIT

FRANCE



BLAGNAC

Élégant & Intemporel

MADE IN FRANCE

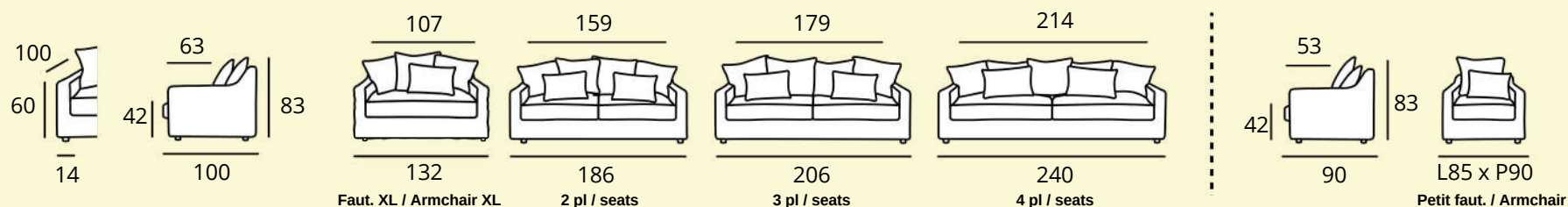

360°
* Option : petit
fauteuil pivotant /
swivel armchair

Structure : Hêtre, panneaux multiplex et panneaux de fibres. Structure enrobée de mousse polyuréthane et d'une sous-housse en foamé agrafée, suspension ressorts Nosags. **Assise** : Plumtex HR 35 kg/m³ + percale remplissage plumes. **Dossier** : Coussins 60 x 60 cm, remplissage plumes/flocons. **Coussins déco** : Coussins 60 x 45 cm, remplissage plumes/flocons. **Pieds** : Bois, teinté wengé. **Finition** : Tapissier.

Frame: Beech wood, multiplex and fiber panels. Frame wrapped in foam cover. Suspension no-sag springs. **Seat cushions**: Plumtex HR foam 35 kg/m³ + layer of feathers. **Back cushions**: cushions 60x60 cm, feathers/foam flake. **Deco cushions**: cushions 60x45 cm, feathers/foam flake. **Legs**: Wooden, wengé. **Finish**: Fixed covers.

Nb de coussins (cushions number) : Dos/Déco (back/deco) = Fauteuil : 1/1 - Fauteuil XL : 3/1 - 2 pl : 4/2 - 3 pl : 4/2 - 4 pl : 5/2.

HOME SPIRIT

FRANCE



homespirit.fr



MADE IN FRANCE

CAP FERRET

& SAINT MARTIN

Élégance & Charme



HOME SPIRIT

FRANCE



CAP FERRET & SAINT MARTIN

Élégance & Charme

MADE IN FRANCE



* Option :

Point bourdon / Overcast stitch.

CAP FERRET Profondeur 90 cm

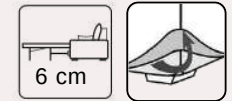
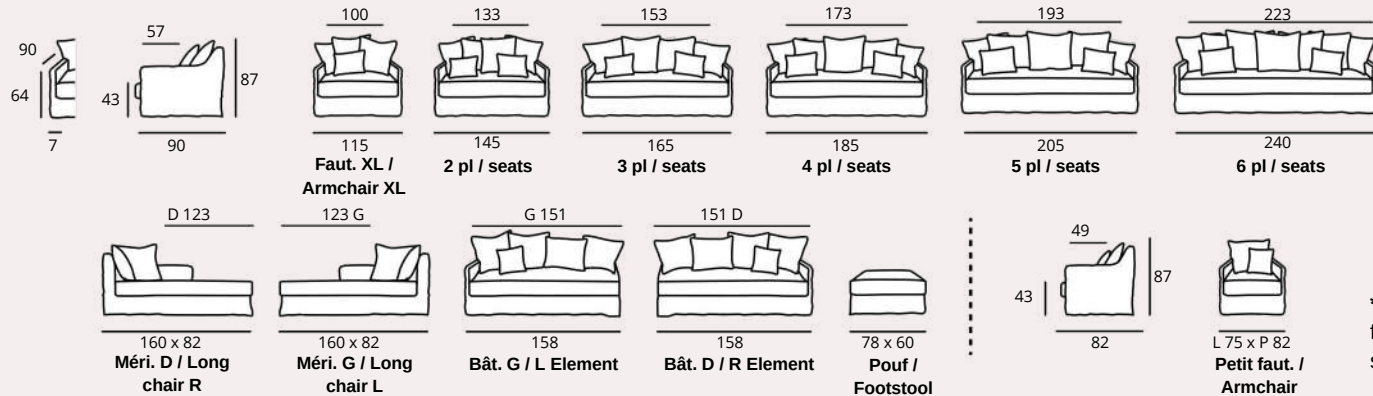

360°
* Option : petit
fauteuil pivotant /
swivel armchair

SAINTE MARTIN Profondeur 100 cm

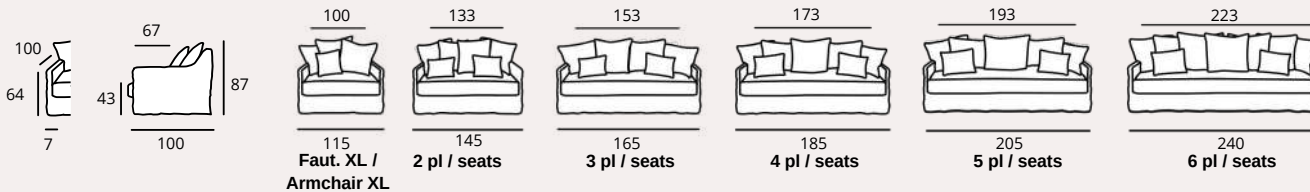

Structure : Hêtre, panneaux multiplex et panneaux de fibres. Structure enrobée de mousse polyuréthane et d'une sous-housse en foamé agrafée, suspension ressorts Nosags. **Assise :** Plumtex HR 35 kg/m³ + percale remplissage plumes. **Dossier :** Coussins 60 x 60 cm, remplissage plumes/flocons. **Coussins de déco :** Coussins 45 x 45 cm, remplissage en plumes/flocons. **Pieds :** Bois. **Couture :** bord à bord / pincé. **Finition :** déhoussable. *Option : Point bourdon - Convertible 6 cm - Petit fauteuil pivotant.

Frame: Beech wood, multiplex panels and fiber panels. Frame wrapped in foam cover. Suspension nosag springs. **Seat cushions:** Plumtex HR 35kg/m³ + layer of feathers. **Back cushions:** cushions 60x60cm, feathers/foam flakes. **Deco cushions:** cushions 45x45cm, feathers/foam flakes. **Legs:** Wooden. **Sewing:** Pinched sewing. **Finish:** Removable covers. *Option : Overcast stitch - Sofa bed 6 cm - Swivel armchair

Nb de coussins (cushions number) : Dos/Déco (back/deco) = Fauteuil : 1/1 - Faut. XL : 3/1 - 2 pl : 4/2 - 3 pl : 4/2 - 4 pl : 5/2 - 5 pl : 5/2 - 6 pl : 7/2 - Méridienne : 2/1 - Bâtard : 4/1.

HOME SPIRIT

FRANCE



homespirit.fr

MADE IN FRANCE

CASSIS

Convertible Grand Confort 14cm



HOME SPIRIT

FRANCE

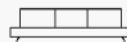

CASSIS

Convertible Grand Confort 14cm

MADE IN FRANCE

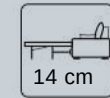
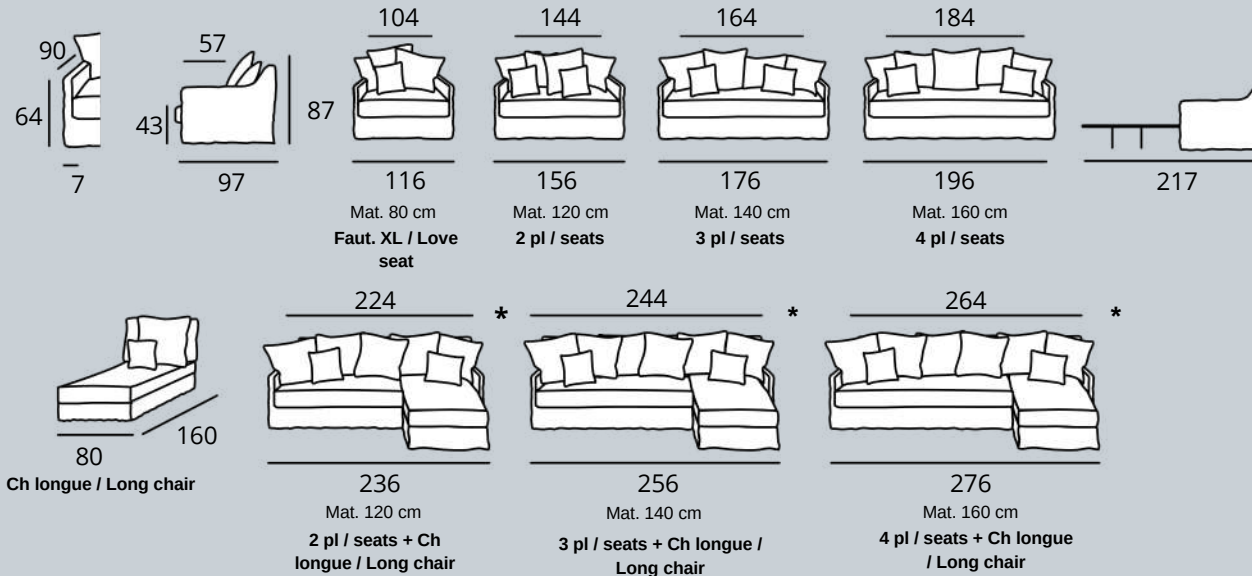

*Angle réversible, méridienne repositionnable à gauche ou à droite

Nb de coussins dossier (cushions number)

: Arrière/Avant/Déco (back/front/deco) = Faut

XL : 1/3/1 - 2 pl : 2/4/2 - 3 pl : 2/4/2 - 4 pl :

2/5/2 - Méridienne : 1/1/1.

Structure : Hêtre, panneaux multiplex et panneaux de fibres. Mécanique autoporteuse sommier grille et sangles entrecroisées en pieds ou mécanique autoporteuse Black Edition sommier latte (bi-zone pour 3 et 4 places) et sangles entrecroisées en pieds. **Assise** : Plumtex HR 35 kg/m³ + percale remplissage plumes. **Dossier** : **Arrière** : Deux grands coussins placés, mousse polyether 20 kg/m³. **Avant** : Coussins 60 x 60 cm, remplissage plumes/flocons. **Coussins de déco** : Coussins 45 x 45 cm, remplissage plumes/flocons. **Finition** : Déhoussable. **Matelas** : 14 cm Mousse HR Optimum 35 kg/m³. Dimensions : 80-120-140-160 x 200 cm. Assises et dossiers arrière restent en place à l'ouverture de la mécanique.

Frame : Solid beech wood, multiplex panels and fiber panels. **Selfsupporting bed mechanism** : Grid and elastic bands or selfsupporting bed mechanism Black Edition : slatted (bi-zone for 3 and 4 seats) and elastic bands. **Seat cushions**: Plumtex HR 35 kg/m³ + layer of feathers. **Back cushions**: **Back**: rectangular cushions, polyether foam 20 kg/m³. **Front**: 60x60cm filled with feathers/foam flakes. **Deco cushions**: 45x45cm with feathers/foam flakes. **Finish**: Removable covers. **Mattress**: 14 cm thick, HR foam Optimum 35 kg/m³. Dimensions 80-120-140-160 x 200 cm. No need to remove rectangular back cushions and seat cushions when folding and unfolding.

HOME SPIRIT

FRANCE



homespirit.fr



MADE IN FRANCE

CAP VERT & SAINT BARTH

Élégance & Charme



HOME SPIRIT

FRANCE



CAP VERT & SAINT BARTH

Élégance & Charme

MADE IN FRANCE



* Option :
Point bourdon / Overcast stitch.

CAP VERT

Profondeur 90 cm

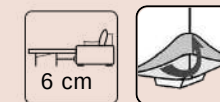
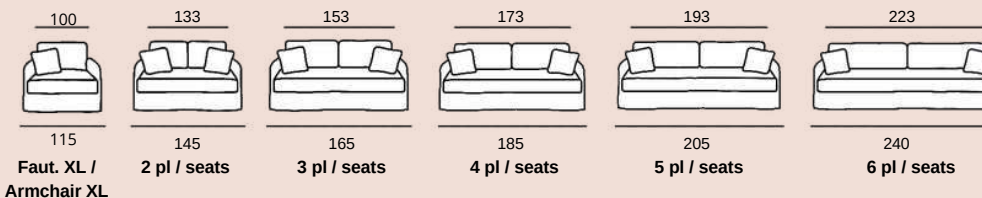
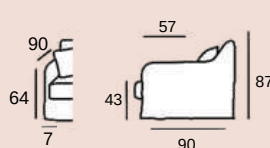

SAINT BARTH

Profondeur 100 cm

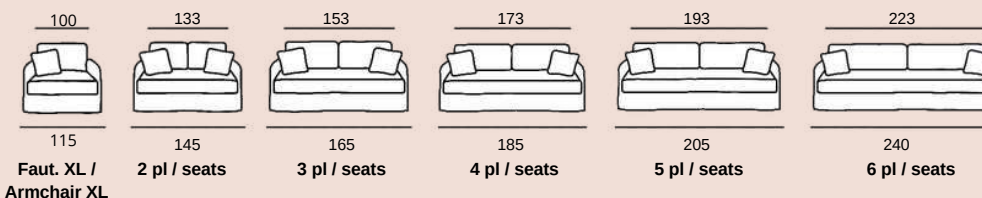
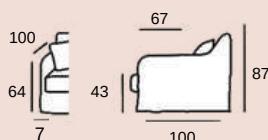

Structure : Hêtre, panneaux multiplex et panneaux de fibres. Structure enrobée de mousse polyuréthane et d'une sous-housse en foamé agrafée, suspension ressorts Nosags. **Assise :** Plumtex HR 35 kg/m³ + percale remplissage plumes. **Dossier :** 2 coussins de dos, remplissage plumes/flocons. **Coussins de déco :** Coussins 45 x 45 cm, remplissage en plumes/flocons. **Pieds :** Bois. **Couture :** bord à bord / pincé. **Finition :** déhoussable. ***Option :** Point bourdon - Convertible 6 cm.

Frame: Beech wood, multiplex panels and fiber panels. Frame wrapped in foam cover. Suspension nosags spings. **Seat cushions:** Plumtex HR 35kg/m³ + layer of feathers. **Back cushions:** 2 cushions, feathers/foam flake. **Deco cushions:** cushions 45x45cm, feathers/foam flakes. **Legs:** Wooden. **Sewing:** Pinched sewing. **Finish:** Removable covers. ***Option :** Overcast stitch - Sofa bed 6 cm.

HOME SPIRIT

FRANCE



homespirit.fr

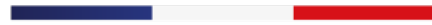

MADE IN FRANCE

CAP HORN

Convertible Grand Confort 14cm



HOME SPIRIT

FRANCE

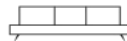

CAP HORN

Convertible Grand Confort 14cm

MADE IN FRANCE

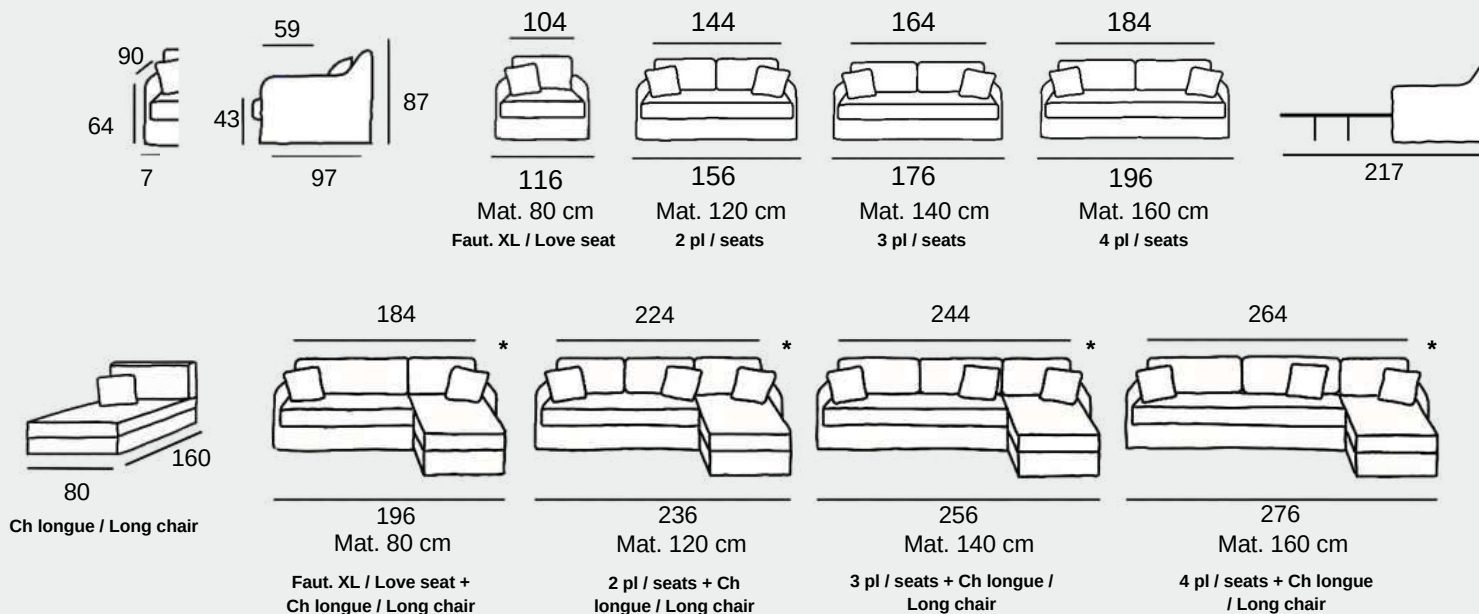

*Angle réversible à gauche ou à droite

*Corner réversible R/L

Structure : Hêtre, panneaux multiplex et panneaux de fibres. Mécanique autoporteuse sommier grille et sangles entrecroisées en pieds ou mécanique autoporteuse Black Edition sommier latte (bi-zone pour 3 et 4 places) et sangles entrecroisées en pieds. **Assise** : Plumtex HR 35 kg/m³ + percale remplissage plumes. **Dossier** : remplissage plumes/flocons. **Coussins de déco** : Coussins 45 x 45 cm, remplissage plumes/flocons. **Finition** Déhoussable. **Pieds** : Bois. **Matelas** : 14 cm Mousse HR Optimum 35 kg/ m³. Dimensions : 80-120-140-160 x 200 cm. Assises et dossiers restent en place à l'ouverture de la mécanique.

Frame: Solid beech wood, multiplex panels and fiber panels. **Selfsupporting bed mechanism** : Grid and elastic bands or selfsupporting bed mechanism Black Edition : slatted (bi-zone for 3 and 4 seats) and elastic bands. **Seat cushions**: Plumtex HR 35 kg/m³ + layer of feathers. **Back cushions**: filled with feathers/foam flakes. **Deco cushions**: cushions 45 x 45 cm, feathers/foam flakes. **Finish**: Removable covers. **Legs**: Wooden. **Mattress**: 14 cm thick, HR foam Optimum 35 kg/m³. Dimensions 80-120-140-160 x 200 cm. No need to remove back and seat cushions when folding and unfolding.

HOME SPIRIT

FRANCE



homespirit.fr

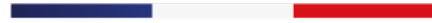

MADE IN FRANCE

CHAMONIX

& CHAMBORD

Actuel & Moelleux



HOME SPIRIT

FRANCE

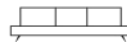

CHAMONIX & CHAMBORD

Actuel & Moelleux

MADE IN FRANCE

CHAMONIX

Profondeur 110 cm

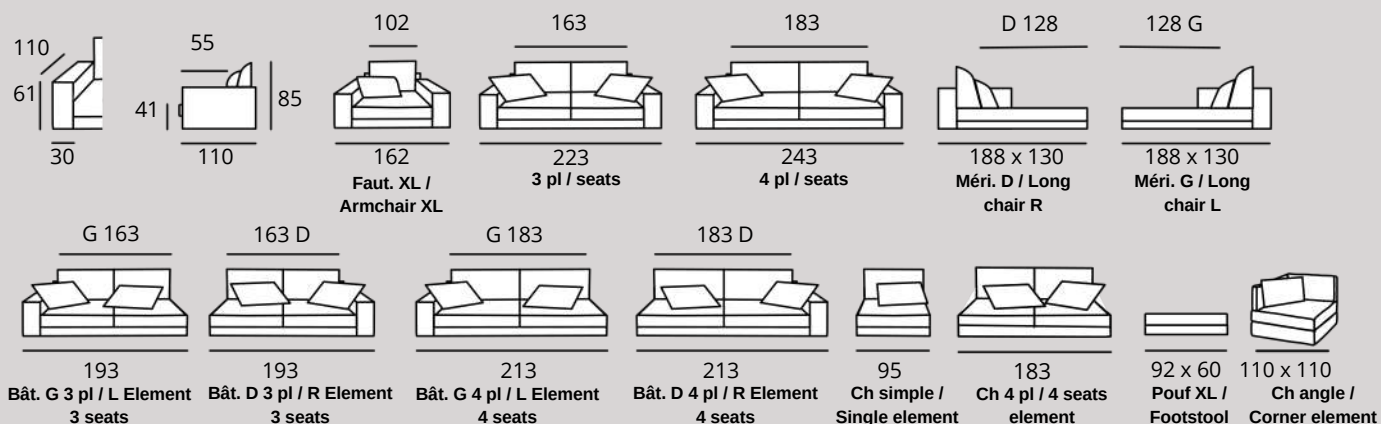

CHAMBORD

Profondeur 100 cm

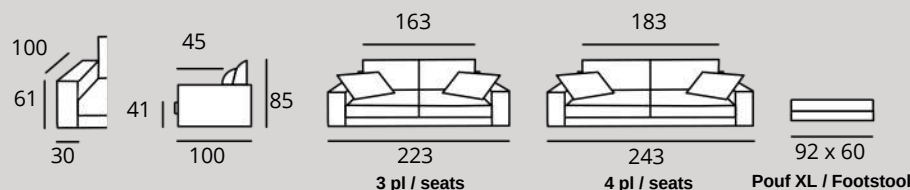

Structure : Hêtre, panneaux multiplex et panneaux de fibres. Structure enrobée de mousse polyuréthane. Manchette enrobée de ouate 650g et surmontée d'une percale en plumes, suspension ressorts Nosags. **Assise :** Plumtex mousse HR 35 kg/m³ + percale de plumes. **Dossier :** **Arrière :** Coussins rectangulaires, remplissage plumes/flocons. **Avant :** Coussins remplissage plumes/flocons. **Coussins déco :** 2 coussins, remplissage plumes/flocons. **Pieds :** Bois. **Finition :** Tapissier.

Frame: Beech wood, multiplex and fiber panels. Frame wrapped in foam cover. Arm covered with a 650 g cotton-wool & double layered with a percale cover with feathers. Suspension nosags springs. **Seat cushions:** Plumtex HR foam 35 kg/m³ + layer of feathers. **Back cushions:** **Back:** Rectangular cushions, feathers/foam flakes. **Front:** cushions filled with feathers/foam flakes. **Deco cushions:** 2 cushions filled with feathers/foam flakes. **Legs:** Wooden. **Finish:** Fixed covers.

HOME SPIRIT

FRANCE



homespirit.fr

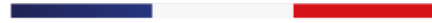

MADE IN FRANCE

COLOGNE

Actuel & Moelleux



HOME SPIRIT

FRANCE



COLOGNE

Actuel & Moelleux

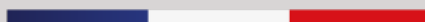

MADE IN FRANCE

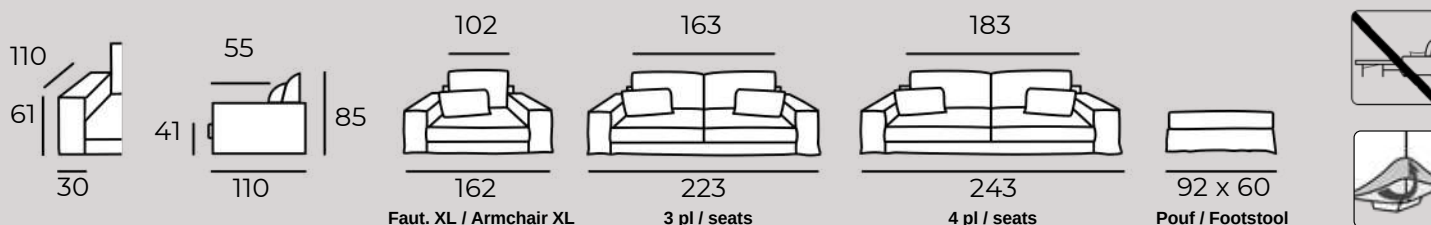

Structure : Hêtre, panneaux multiplex et panneaux de fibres. Structure enrobée de mousse polyuréthane. Manchette enrobée de ouate 650g et surmontée d'une percale en plumes, suspension ressorts Nosags. **Assise :** Plumtex mousse HR 35 kg/m³ + percale de plumes. **Dossier : Arrière :** Coussins rectangulaires, remplissage plumes/flocons - **Avant :** Remplissage plumes/flocons. **Coussins déco :** 2 coussins remplissage plumes/flocons. **Pieds :** Bois. **Finition :** Déhoussable.

Frame: Beech wood, multiplex and fiber panels. Frame wrapped in foam cover. Arm covered with a 650 g cotton-wool & double layed with a percale cover with feathers. Suspension nosag springs. **Seat cushions:** Plumtex HR foam 35 kg/m³ + layer of feathers - **Back cushions: Back:** Rectangular cushion, feathers/foam flakes - **Front:** cushions filled with feathers/foam flakes - **Deco cushions:** 2 cushions filled with feathers/foam flakes. **Legs:** Wooden. **Finish:** Removable covers.

HOME SPIRIT

FRANCE



homespirit.fr

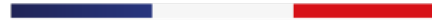

MADE IN FRANCE

CHARLES

Convertible Grand Confort 14cm



HOME SPIRIT

FRANCE



CHARLES

Convertible Grand Confort 14cm

MADE IN FRANCE

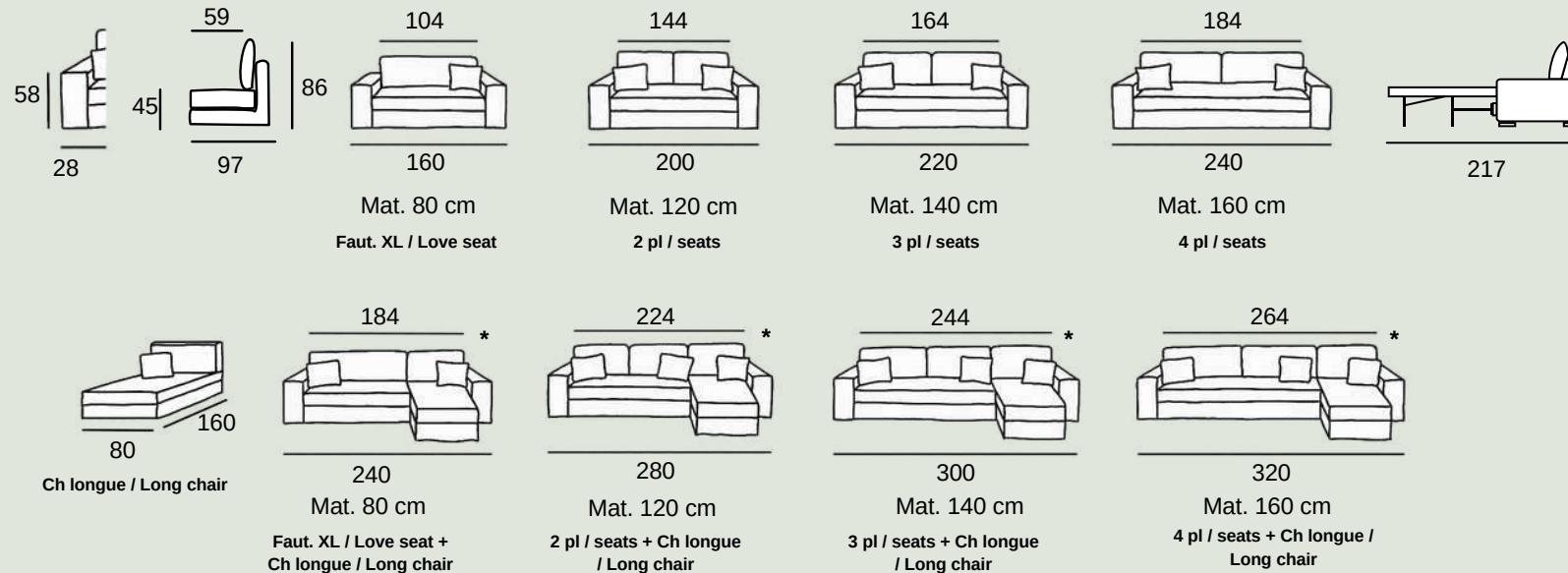

*Angle réversible à gauche ou à droite

*Corner réversible R/L

Structure : Hêtre, panneaux multiplex et panneaux de fibres. Mécanique autoporteuse sommier grille et sangles entrecroisées en pieds ou mécanique autoporteuse Black Edition sommier latte (bi-zone pour 3 et 4 places) et sangles entrecroisées en pieds. **Assise :** Plumtex HR 35 kg/m³ + percale remplissage plumes. **Dossier :** remplissage plumes/flocons. **Coussins de déco :** Coussins 40 x 60 cm, remplissage plumes/flocons. **Finition** Déhoussable. **Pieds :** Bois. **Matelas :** 14 cm Mousse HR Optimum 35 kg/ m³. Dimensions : 80-120-140-160 x 200 cm. Assises et dossiers restent en place à l'ouverture de la mécanique.

Frame: Solid beech wood, multiplex panels and fiber panels. **Selfsupporting bed mechanism :** Grid and elastic bands or selfsupporting bed mechanism Black Edition : slatted (bi-zone for 3 and 4 seats) and elastic bands. **Seat cushions:** Plumtex HR 35 kg/m³ + layer of feathers. **Back cushions:** filled with feathers/foam flakes. **Deco cushions:** cushions 40 x 60 cm, feathers/foam flakes. **Finish:** Removable covers. **Legs:** Wooden. **Mattress:** 14 cm thick, HR foam Optimum 35 kg/m³. Dimensions 80-120-140-160 x 200 cm. No need to remove back and seat cushions when folding and unfolding.

HOME SPIRIT

FRANCE



homespirit.fr

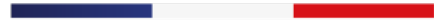

MADE IN FRANCE

FARO

Élégant & Audacieux



HOME SPIRIT

FRANCE

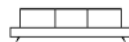

FARO

Élégant & Audacieux

MADE IN FRANCE

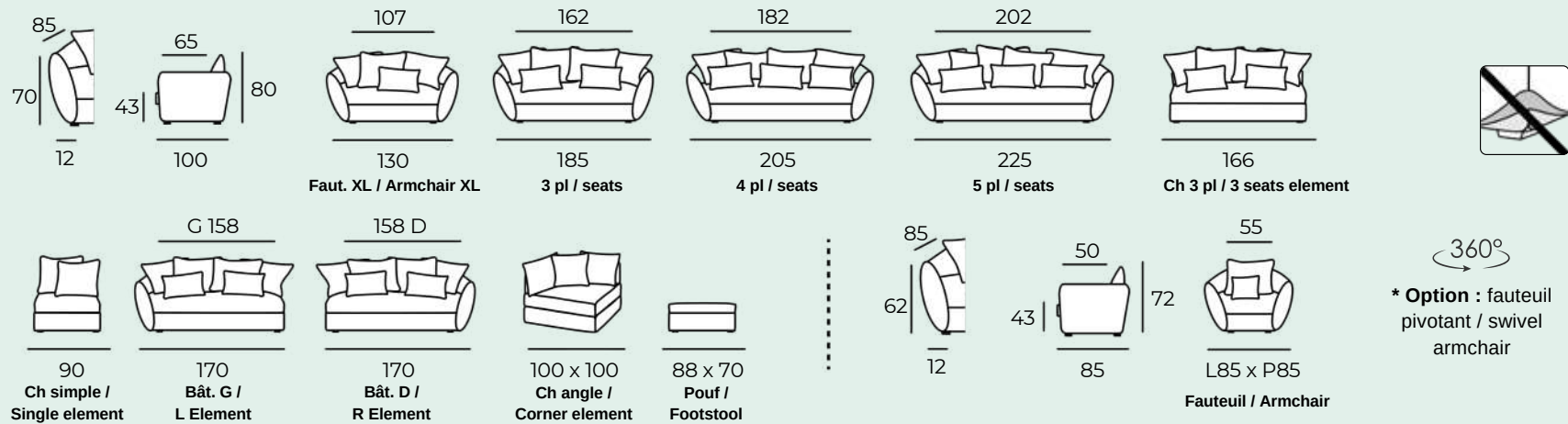

Structure : Hêtre, panneaux multiplex et panneaux de fibres. Structure enrobée de mousse polyuréthane et de ouate 650 g, suspension ressorts Nosags. **Assise :** Plumtex HR 35 kg/m³ + percale remplissage plumes. **Dossier :** Coussins 60 x 60 cm, remplissage plumes/flocons. **Coussins déco :** Coussin 45 x 60 cm, remplissage plumes/flocons. **Pieds :** Bois. **Finition :** Tapissier. ***Option :** Fauteuil pivotant.

Frame: Solid beech wood, multiplex panels and fiber panels. Frame wrapped in foam cover and double layered with a fiber cover. Suspension Nosags springs. **Seat cushions:** Plumtex HR 35 kg/m³ + layer of feathers. **Back cushions:** Cushions 60x60cm, feathers/foam flakes. **Deco cushions:** Cushions 45x60cm, feathers/foam flakes. **Legs:** Wooden. **Finish:** Fixed covers. ***Option :** Swivel armchair

Nb de coussins (cushions number) : Dos/Déco (back/deco) = Fauteuil : 1/1 - Fauteuil XL : 3/1 - 4 places : 4/3 - 5 places : 5/3 - Bâtard 3 places : 4/2 - Chauffeuse simple : 2/0 - Chauffeuse 3 places : 4/2 - Chauffeuse d'angle : 3/0 - Pouf : 0/0.

HOME SPIRIT

FRANCE



homespirit.fr

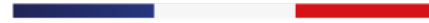

MADE IN FRANCE

FIGARI

Élégant & Audacieux



HOME SPIRIT

FRANCE

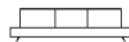

FIGARI

Élégant & Audacieux

MADE IN FRANCE

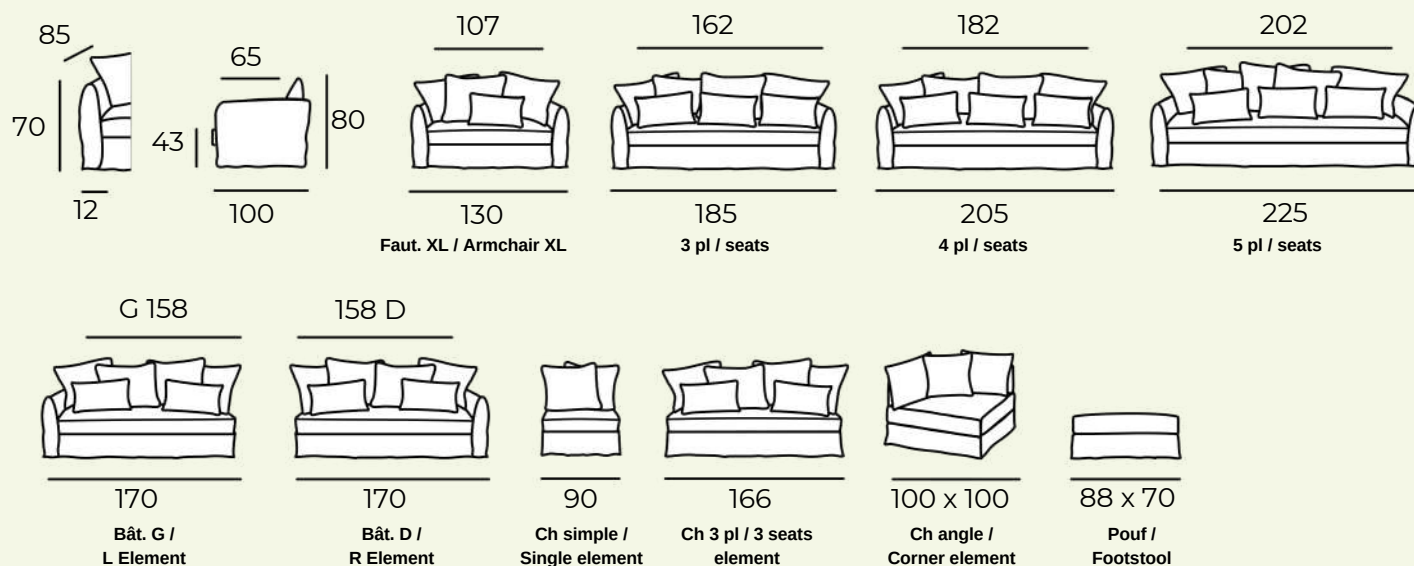

Structure : Hêtre, panneaux multiplex et panneaux de fibres. Structure enrobée de mousse polyuréthane et de ouate 650 g, suspension ressorts Nosags. **Assise :** Plumtex HR 35 kg/m³ + percale remplissage plumes. **Dossier :** Coussins 60 x 60 cm, remplissage plumes/flocons. **Coussins déco :** Coussin 45 x 60 cm, remplissage plumes/flocons. **Pieds :** Bois. **Finition :** 100% déhoussable.

Frame: Solid beech wood, multiplex panels and fiber panels. Frame wrapped in foam cover and double layered with a fiber cover. Suspension Nosag springs. **Seat cushions:** Plumtex HR 35 kg/m³ + layer of feathers. **Back cushions:** Cushions 60x60cm, feathers/foam flakes. **Deco cushions:** Cushions 45x60cm, feathers/foam flakes. **Legs:** Wooden. **Finish:** Removable covers.

Nb de coussins (cushions number) : Dos/Déco (back/deco) = Fauteuil XL : 3/1 - 3 places : 4/3 - 4 places : 4/3 - 5 places : 5/3 - Bâtard 3 places : 4/2 - Chauffeuse simple : 2/0 - Chauffeuse 3 places : 4/2 - Chauffeuse d'angle : 3/0 - Pouf : 0/0 - Fauteuil XL+Pouf : 3/1.

HOME SPIRIT

FRANCE



homespirit.fr

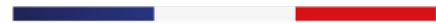

MADE IN FRANCE

FIGEAC

Chic & Généreux



HOME SPIRIT

FRANCE

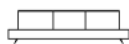

FIGEAC

Chic & Généreux

MADE IN FRANCE

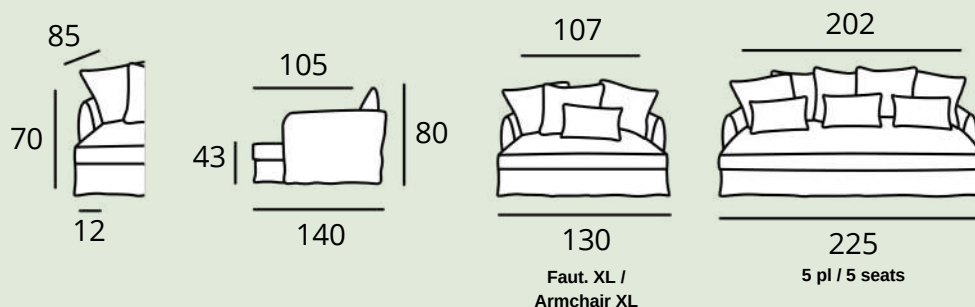

Structure : Hêtre, panneaux multiplex et panneaux de fibres. Structure enrobée de mousse polyuréthane et de ouate 650 g, suspension ressorts Nosags. **Assise** : Plumtex HR 35 kg/m³ + percale remplissage plumes. **Dossier** : Coussins 60 x 60 cm, remplissage plumes/flocons. **Coussins déco** : Coussin 45 x 60 cm, remplissage plumes/flocons. **Pieds** : Bois. **Finition** : 100% déhoussable.

Frame: Solid beech wood, multiplex panels and fiber panels. Frame wrapped in foam cover and double layered with a fiber cover. Suspension No-sags springs. **Seat cushions**: Plumtex HR 35 kg/m³ + layer of feathers. **Back cushions**: Cushions 60x60cm, feathers/foam flakes. **Deco cushions**: Cushions 45x60cm, feathers/foam flakes. **Legs**: Wooden. **Finish**: Removable covers.

Nb de coussins (cushions number) : Dos/Déco (back/deco) = Fauteuil XL : 3/1 - 5 places : 5/3.

Modèle composé d'un canapé et d'un élément type pouf, à fixer à l'aide de pinces crocodiles.

Sofa with two elements, to assemble with crocodile clips.

HOME SPIRIT

FRANCE



homespirit.fr

MADE IN FRANCE

NOMAD

Confortable & Généreux



HOME SPIRIT

FRANCE

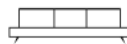

NOMAD

Confortable & Généreux

MADE IN FRANCE

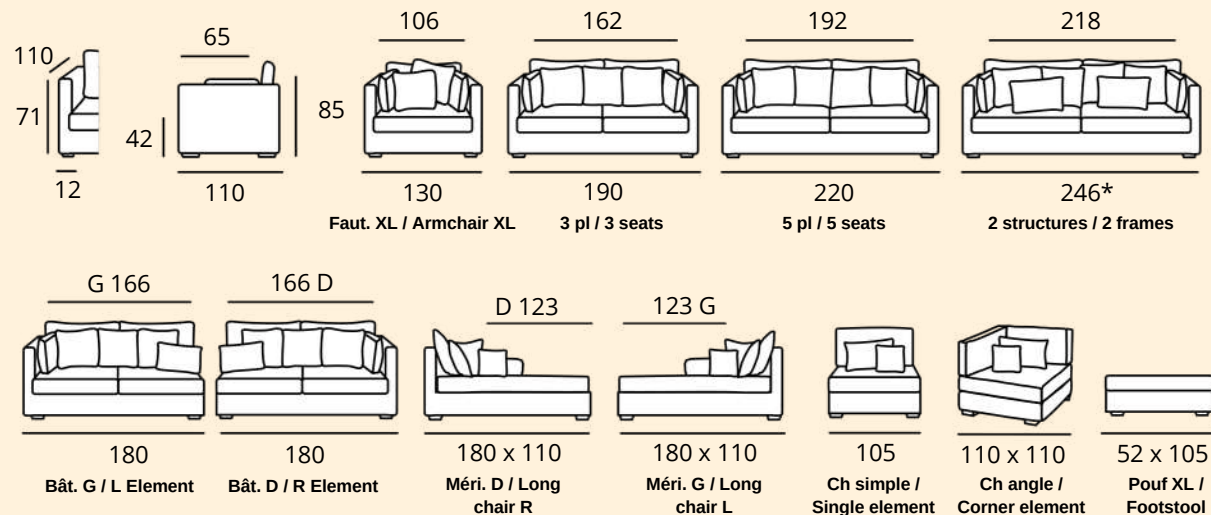

Structure : Hêtre, panneaux multiplex et panneaux de fibres. Structure enrobée de mousse polyuréthane et d'une sous-housse en foamé agrafée, suspension ressorts Nosags. **Assise** : Plumtex HR 35 kg/m³ + percale remplissage plumes. **Dossier** : **Arrière** : Coussins rectangulaires, remplissage plumes/flocons - **Avant** : Coussins 45 x 45 cm, remplissage plumes/flocons. **Coussins accoudoirs** : Coussin 60 x 40 cm, remplissage plumes/flocons. **Pieds** : Bois. **Finition** : Déhoussable. * La caisse du canapé 246 cm est livrée en 2 pièces : 2 structures de bâtard de 123 cm avec une housse unique de 246 cm.

Frame: Beech wood, multiplex and fiber panels. Frame wrapped in foam cover. Suspension Nosags springs. **Seat cushions**: Plumtex HR foam 35 kg/m³ + layer of feathers. **Back cushions**: **Back**: Rectangular cushions, feathers/foam flakes - **Front**: Cushion 45x45 cm, filled with feathers/foam flakes. **Arm cushion**: Cushion 60x40cm, filled with feathers/foam flakes. **Legs**: Solid wooden. **Finish**: Removable covers. * Sofa 246 cm is made of 2 frames : with one unique fabric cover on the structure.

Nb de coussins dossier (cushions number) : Arrière/Avant/Accoudoirs (back/front/arm) = Faut XL : 1/2/2 - 3 pl : 2/3/2 - 5 pl : 2/4/2 - 6 pl : 2/4/4 - Bâtard : 2/3/2 - Méridienne : 1/2/1 - Ch simple : 1/1/1 - Ch angle : 2/1/1.

HOME SPIRIT

FRANCE



homespirit.fr

MADE IN FRANCE

PETER

Urbain & Raffiné

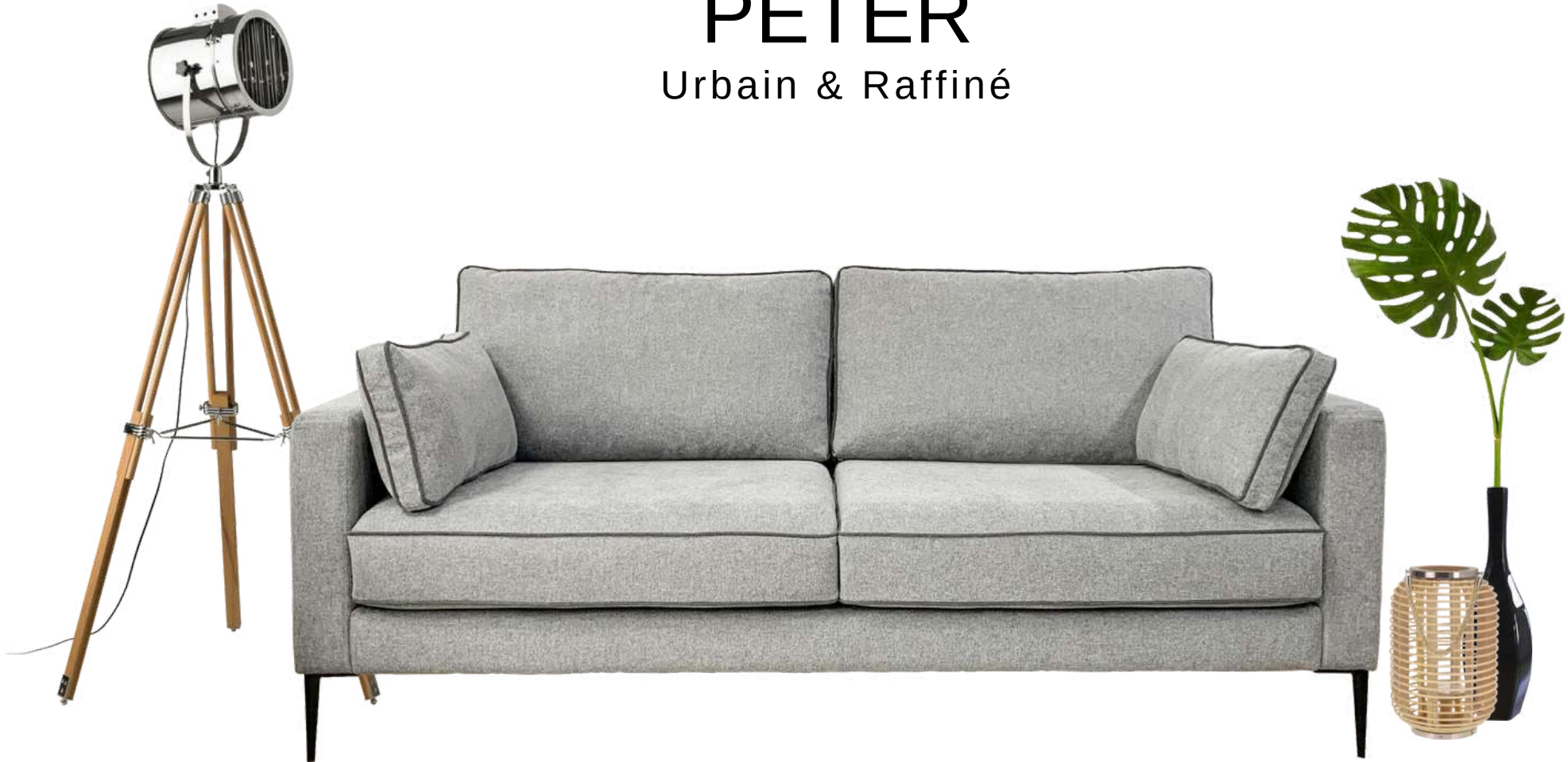

HOME SPIRIT

FRANCE

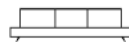

PETER

Urbain & Raffiné

MADE IN FRANCE

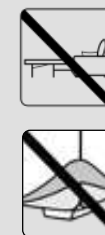
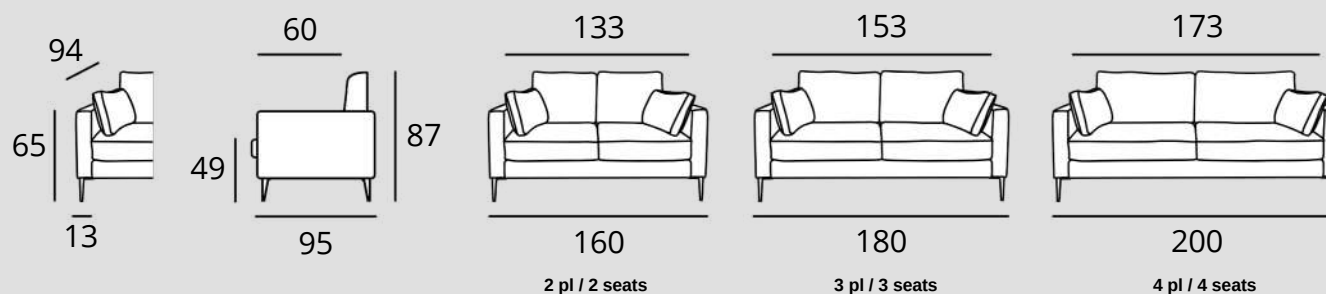

Structure : Bois massif, panneaux de fibres et panneaux de particules. **Assise :** Mousse HR 35 kg/m³ + HR 26 kg/m³. **Dossier :** Coussins rectangulaires, remplissage fibres creuses siliconées. **Coussins déco :** 2 x coussins 60 x 30 cm, remplissage fibres. **Pieds :** Métal - noir - hauteur 17 cm. **Couture :** Surpiqûre plate sur la structure. Passepoil sur les coussins d'assise, de dos et de déco. **Finition :** Tapissier.

Frame: Solid beech wood, fiber panels and multiplex panels. **Seat cushions:** HR foam 35 kg/m³ + HR 26 kg/m³. **Back cushions:** Fibers. **Deco cushion:** 60x30cm fibers. **Legs:** Metal - black - height 17 cm. **Sewing:** Flat topstitch on the frame. Piping on seat, back and deco cushions. **Finish:** Fixed covers.



homespirit.fr

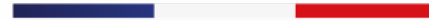

MADE IN FRANCE

SPENCER

Intemporel & Compact



HOME SPIRIT

FRANCE

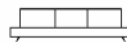

SPENCER

Intemporel & Compact

MADE IN FRANCE

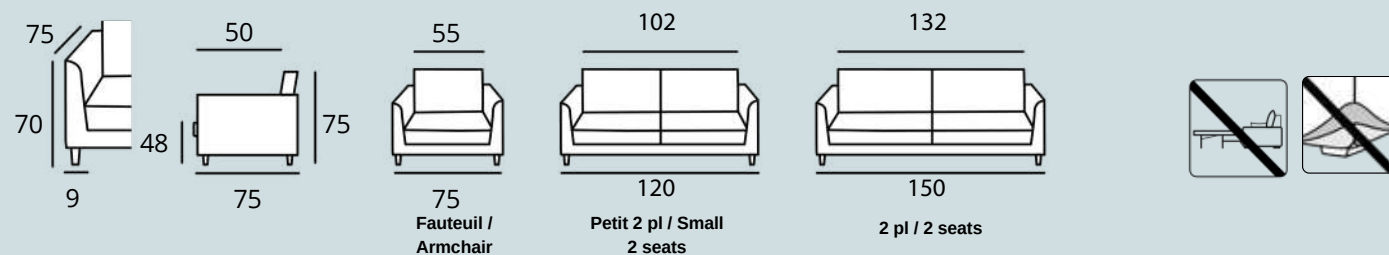

Structure : Hêtre, panneaux multiplex et panneaux de fibres. Structure enrobée de mousse polyuréthane et d'une sous-housse en foamé agrafée, suspension sangles. **Assise** : Mousse HR 35 kg/m³ + HR 23 kg/m³. **Dossier** : Remplissage fibres creuses siliconées. **Pieds** : Métal noir. **Finition** : Tapissier.

Frame: Beech wood, multiplex and fiber panels. Frame wrapped in foam cover. Suspension elastic bands. **Seat cushions**: HR foam 35 kg/m³ + HR foam 23 kg/m³. **Back cushions**: fibers. **Legs** : Black metal. **Finish**: Fixed covers.

HOME SPIRIT

FRANCE



homespirit.fr

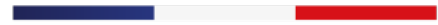

MADE IN FRANCE

TACOMA

Compact & Réversible



TACOMA

Compact & Réversible

MADE IN FRANCE

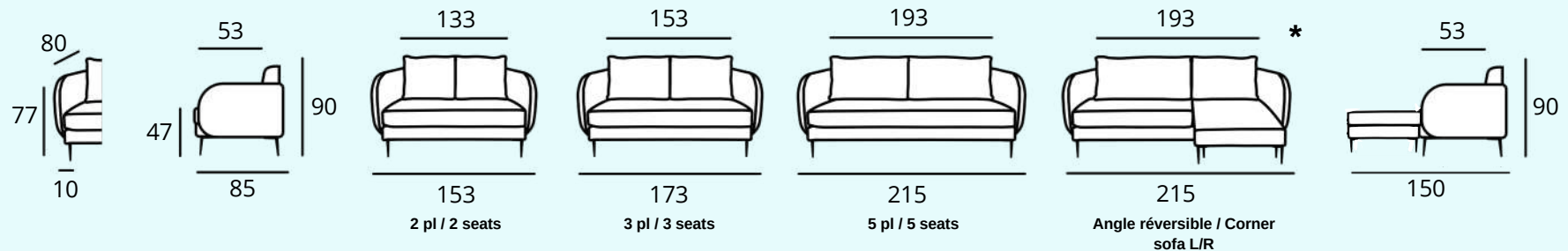

Structure : Bois massif, panneaux de fibres et panneaux de particules. Suspension d'assise ressorts Nosags. **Assise :** Mousse HR 35 kg/m³ + HR 26 kg/m³ - Coussin mono-assise pour 2 pl, 3 pl et 5 pl - Deux assises pour l'angle. **Dossier :** Coussins rectangulaires, remplissage fibres creuses siliconées. **Pieds :** Métal - noir - hauteur 17 cm. **Couture :** Sellier. **Finition :** Tapissier.

Frame: Solid beech wood, fiber panels and multiplex panels. Suspension Nosags springs. **Seat cushions:** HR foam 35 kg/m³ + HR 26 kg/m³. Only one cushion for 2 seats, 3 seats and 5 seats - Two cushions for corner sofa. **Back cushions:** Fibers. **Legs:** Metal - black - height 17 cm. **Sewing:** Double stitching. **Finish:** Fixed covers.

* Canapé d'angle réversible composé d'un canapé et d'un pouf : pouf, assises et dossiers repositionnables à gauche ou à droite.
 Reversible corner sofa including sofa + footstool : footstool, seats and back cushions can be set on the left or on the right.

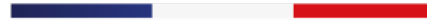

MADE IN FRANCE

VANG

Contemporain & Épuré



HOME SPIRIT

FRANCE

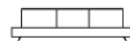

VANG

Contemporain & Épuré

MADE IN FRANCE

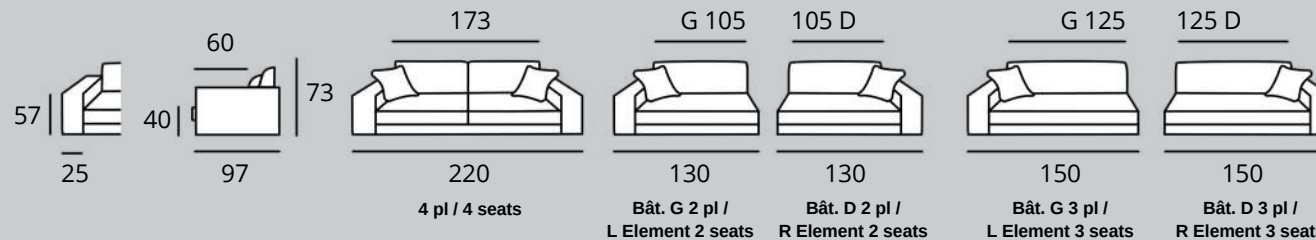

Structure : Hêtre, panneaux multiplex et panneaux de fibres. Structure enrobée de mousse polyuréthane et d'une housse en foamé aggrafée. Suspension ressorts Nosags. **Assise** : Mousse HR 35 kg/m³ + HR 25 kg/m³. **Dossier** : Coussins rectangulaires, fibres creuses siliconées. **Coussins déco** : Remplissage plumes/flocons. **Pieds** : Bois. **Finition** : Tapissier.

Frame: Beech wood, multiplex panels and fiber panels. Frame wrapped in polyurethane foam with a white foam cover. Suspension Nosag springs. **Seat cushions**: HR 35 kg/m³ + HR 25 kg/m³. **Back cushions**: Rectangular cushions, filled with fibers. **Deco cushions**: Filled with feathers/foam flakes. **Legs**: Wooden. **Finish**: Fixed covers.



homespirit.fr

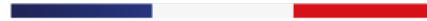

MADE IN FRANCE

FAUTEUILS

Austin, Bandol, Spencer, Faro, Cap Ferret, Biarritz,
Biscarrosse, Blagnac, Beausset

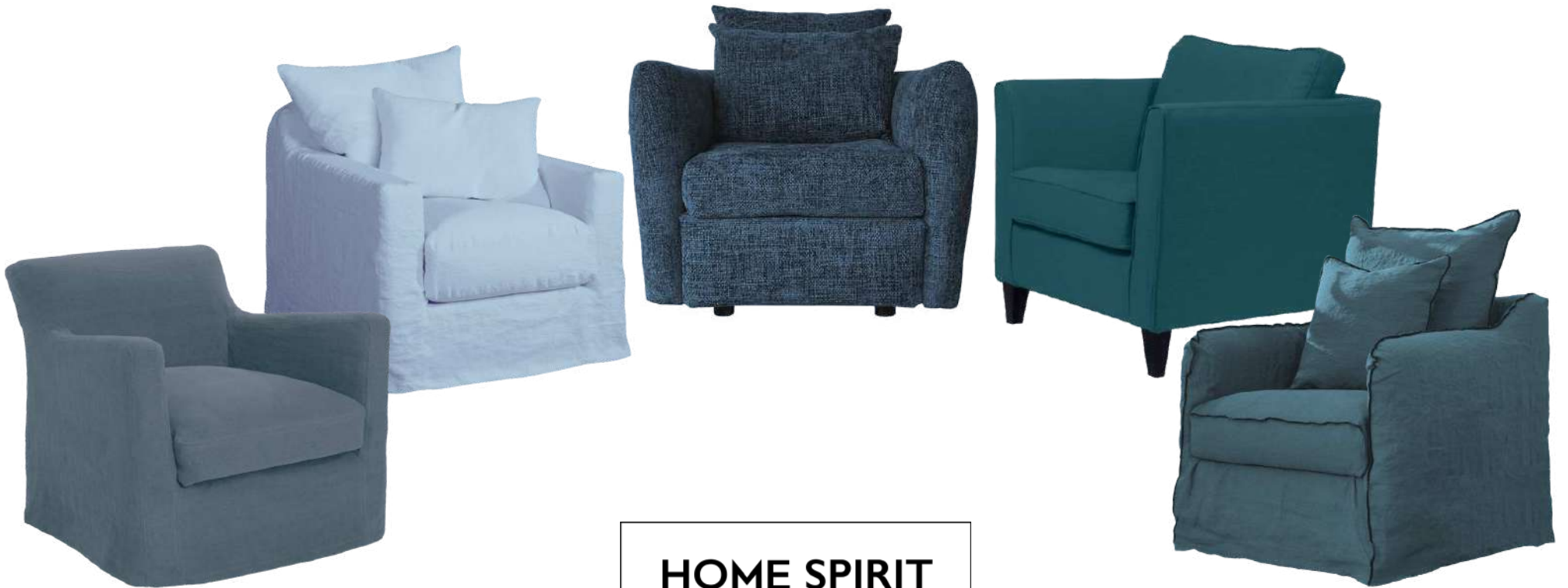

HOME SPIRIT

FRANCE

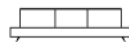

FAUTEUILS

Austin, Bandol, Spencer, Faro, Cap Ferret, Biarritz,
Biscarrosse, Blagnac, Beausset



MADE IN FRANCE



Austin



Bandol



Biarritz



Biscarrosse

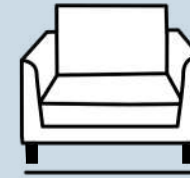

Spencer



Faro



Cap Ferret



Beausset



Blagnac

Pour plus d'informations sur chaque fauteuil, découvrez sa fiche produit sur www.homespirit.fr

For more information on each armchair, discover its product sheet on www.homespirit.fr

HOME SPIRIT

FRANCE



homespirit.fr

MADE IN FRANCE

POUF, DOMINO & TÊTIÈRE

Personnalisés & Pétillants



HOME SPIRIT

FRANCE

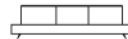

POUF, DOMINO & TÊTIÈRE

Personnalisés & Pétillants



MADE IN FRANCE

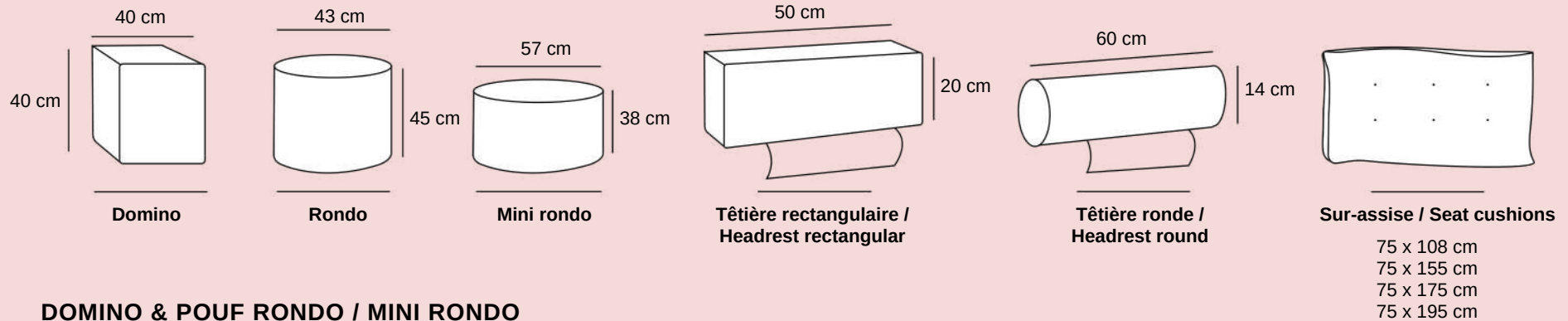

DOMINO & POUF RONDO / MINI RONDO

Structure : Hêtre. Panneaux multiplex. Structure enrobée de mousse polyuréthane. **Finition :** Tapissier.

Frame: Beech wood. Multiplex panels. Frame wrapped in foam cover. **Finish:** Fixed covers.

TÊTIÈRE RECTANGULAIRE OU RONDE / HEADREST

Structure : Mousse 17 kg/m³, support métal. **Finition :** Déhoussable

Frame: Foam 17 kg/m³, metal support. **Finish:** Removable covers.

SUR-ASSISE / SEAT CUSHIONS

Structure : Remplissage fibre. **Finition :** Passepoil.

Frame: Filled with fibers, **Finish:** Stitching in piping.



homespirit.fr



MADE IN FRANCE

GAMME COUSSINS

HOME SPIRIT

FRANCE

GAMME COUSSINS

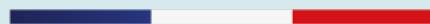

MADE IN FRANCE



45 x 45



30 x 50



40 x 60

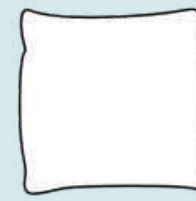

60 x 60

Voir l'ensemble de l'offre sur le tarif.
See the whole range of cushions on the price list.

HOME SPIRIT



homespirit.fr

MADE IN FRANCE

Retrouvez nous sur www.homespirit.fr

